



Features & Benefits

- Retains high-discharge voltage performance.

Specifications

Part number		VL2020
Charging Voltage		3.25V~3.55V
Nominal Voltage		3.0V
Nominal Capacity* ¹		20.0mAh
Continuous drain		0.07mA
Dimensions* ²	Diameter (Max.)	20.0mm
	Height (Max.)	2.0mm
Weight* ²		Approx. 2.10g
Operating Temperature		-20°C to +60°C

*¹ Based on standard drain and cut-off voltage down to 2.0V at 20°C.

*² Without tabs.

Dimensions

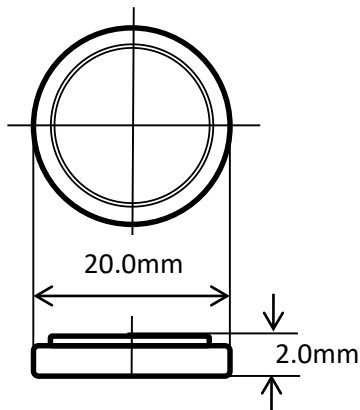

Applications

- Memory backup
- RTC backup
(printers, composite machines, medical equipment, FA equipment), remote keyless entry, fire alarms etc.

Terminal types

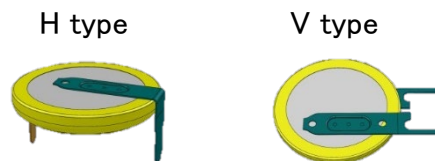

* For more information, please ask Panasonic sales person.

Charging condition

Charging/discharging cycle	Approx. 1,000times at 10% discharge depth to nominal capacity.
Charging system	Constant-voltage system
Operating temperature	-20°C to +60°C

* Please ask Panasonic about constant-current charging system.

The charging circuit is crucial in terms of ensuring that full justice will be done to the battery characteristics. Please study it carefully as the wrong charging circuit can cause trouble.

As of March, 2021. The contents of this product information are subject to change without notice.

Please visit our website at:

Panasonic Corporation

<https://eu.industrial.panasonic.com/products/batteries-energy-products/primary-batteries/lithium-batteries>



Battery Characteristics

Discharging Characteristics

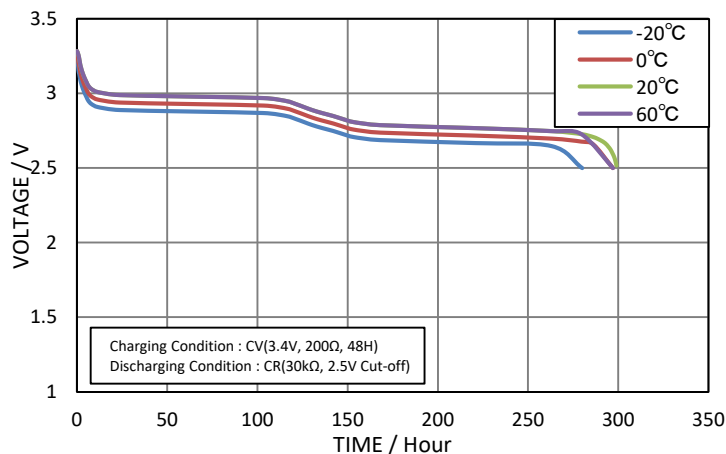

Cycle Life Characteristics

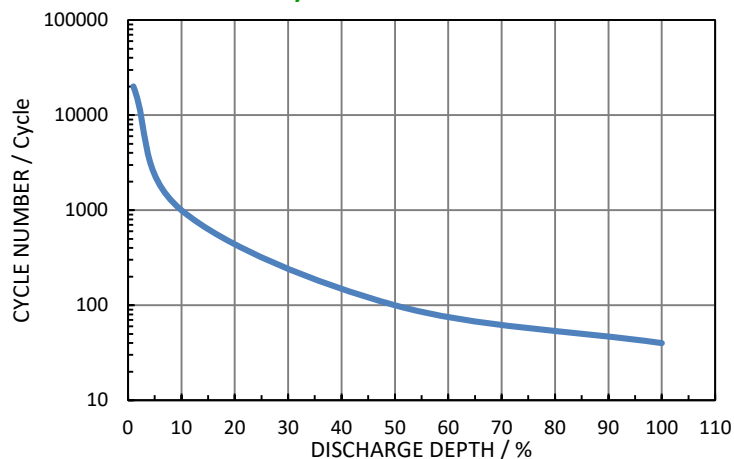

Continuous Charging Characteristics by High Temperature(60°C)

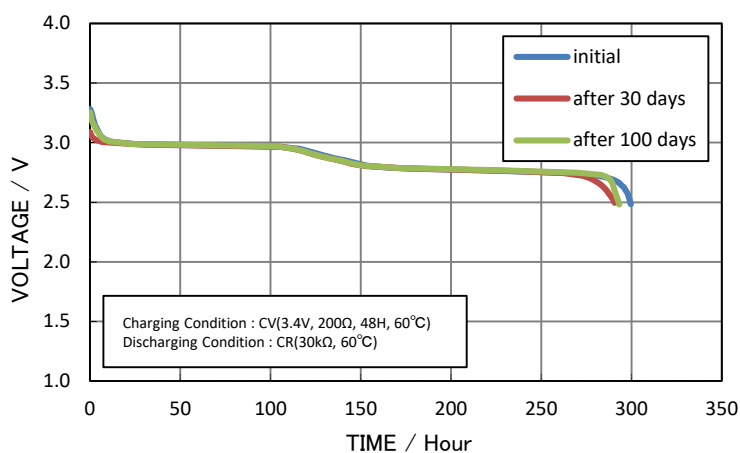

This data in this document is for descriptive purposes only and is not intended to make or imply any guarantee or warranty.

Handling Guidelines

- If a fixed-charging method is applied, please adhere to the specified charging voltage. Guaranteed voltage is 3.4V ± 0.15V at the temperature of -20°C to 60°C.**

If the charging voltage exceeds the specifications, the internal resistance of the battery will rise and may cause battery deterioration.

Also with a charge voltage around 4V, corrosion of the positive(+) terminal (case) may occur causing leakage. It is not possible for the battery to recover completely when the charging voltage is below the specification.

- Under no circumstances trickle charging should be used.**

Ignoring this precaution will cause the battery voltage to rise to about 5V, resulting in a deterioration of performance.

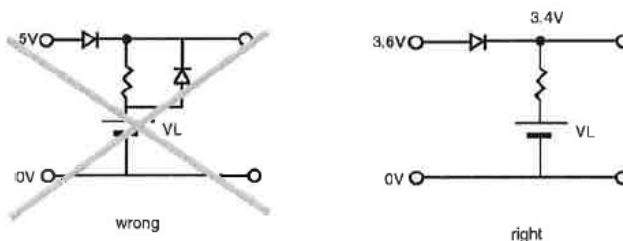

Please feel free to ask a Panasonic sales person.